

MODIFICATION NOTICE

APR4 / SPR4 / APR5 / SPR5 > P 24 / 25 / 26 / 27

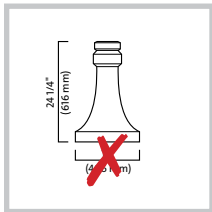

Correction:

Bottom width of the optional decorative base cover **LBC1** is **17 5/8" (443 mm)** and not 16" (406 mm).

SPR5 > P 27

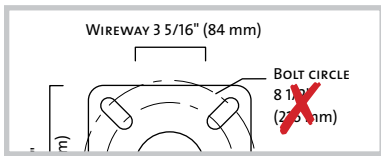

Correction:

The bolt circle of the **SPR5** pole is **12 1/2" (318 mm)** and not 8 1/2" (216 mm).

P135A > P 80

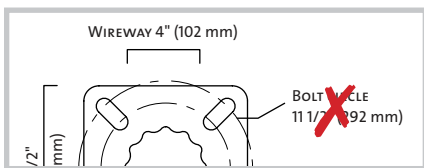

Correction:

The bolt circle of the **P135A** pole is **12 1/2" (318 mm)** and not 11 1/2" (292 mm).

APR5 > P 26

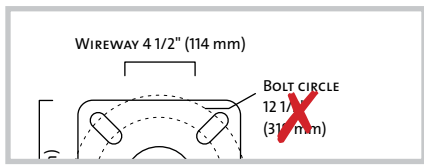

Correction:

The bolt circle of the **APR5** pole is **12 1/2" (318 mm)** and not 8 1/2" (216 mm).

RA805 / RS805 > P 54 / 55

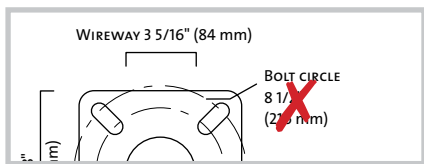

Correction:

The bolt circle of the **RA805 / RS805** pole is **12 1/2" (318 mm)** and not 8 1/2" (216 mm).

RAF805 > P 58

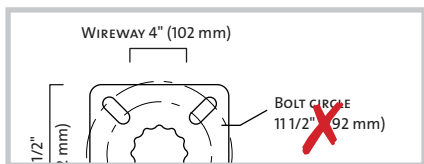

Correction:

The bolt circle of the **RAF805** pole is **12 1/2" (318 mm)** and not 11 1/2" (292 mm).

SPS5 > P 29

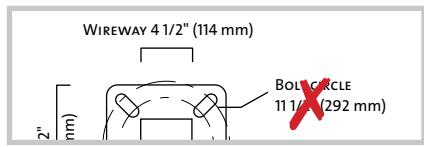

Correction:

The bolt circle of the **SPS5** pole is **12 1/2 po (318 mm)** and not 11 1/2" (292 mm).

PC > P 110

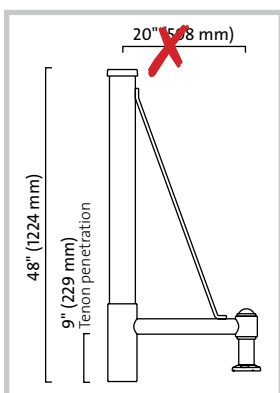

Correction:

The size of the **PC** bracket is **24" (610 mm)** and not 20" (508 mm).

DC6 / DC8 / DR6 / DR8 > P 121

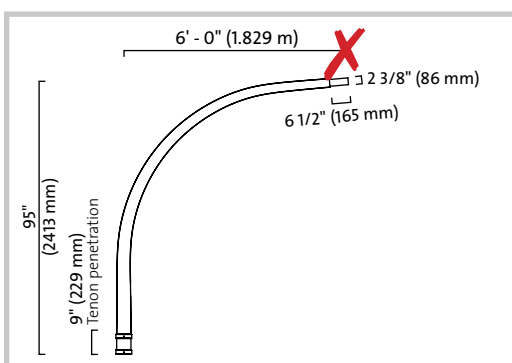

Correction:

The tenon is not included in the given size of the **DC** and **DR** brackets.

RTA61 > P 73

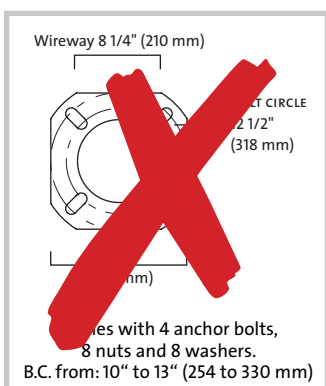

Comes with 4 anchor bolts, 8 nuts and 8 washers. B.C. from: 10" to 13" (254 to 330 mm)

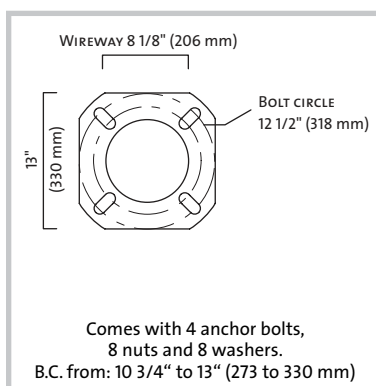

Comes with 4 anchor bolts, 8 nuts and 8 washers. B.C. from: 10 3/4" to 13" (273 to 330 mm)

Correction:

Here is the correct information on the anchor plate for the **RTA61** pole.